

HUDY®

OFF-ROAD

SET-UP BOOK

INSTRUCTION MANUAL & SET-UP THEORY

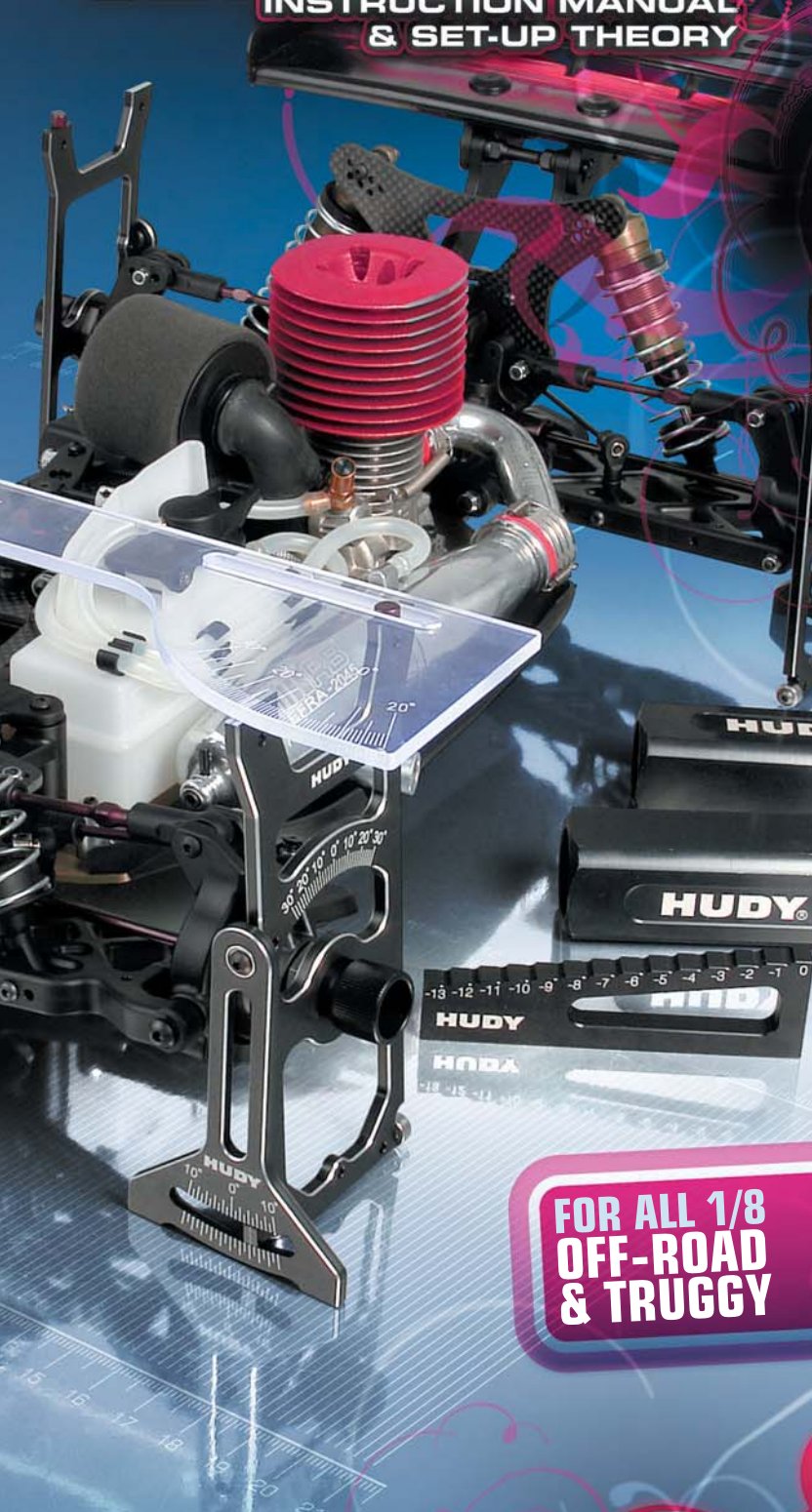

**FOR ALL 1/8
OFF-ROAD
& TRUGGY**

*originals
always
Best*



Introduction	3
Equipment and Tools	4
Set-up System Components	4
Tools and Equipment	5
Assembling and Installing the Set-up Stands	7
Assembling the Set-up Stands	7
Assembling the Set-up Board	8
Installing the Set-up Stands	8
Overview of Car Set-up	9
Downstops	10
Effects of Downstop Adjustment	10
Measuring Downstops	10
Adjusting Downstops	11
Ride Height	12
Effects of Ride Height Adjustment	12
Measuring Ride Height	12
Adjusting Ride Height	13
Camber	14
Effects of Camber Adjustment	14
Measuring Camber	14
Adjusting Camber	16
Track-width	14
Effects of Track-width Adjustment	16
Measuring Track-width	16
Adjusting Track-width	17
Caster	18
Effects of Caster Adjustment	18
Measuring Front Caster	18
Adjusting Front Caster	19
Toe	20
Effects of Toe Adjustment	20
Measuring Toe	20
Adjusting Toe	21
Steering	22
Ackermann	22
Servo Saver Preload	23
Bump Steer	23
Roll Center	24
Front Roll Center	24
Rear Roll Center	25
Shock Absorbers	26
Shock Damping	26
Shock Pistons	26
Shock Oil	27
Shock Springs	27
Shock Mounting Position	28
Shock Preload	28
Kick-up (Front)	29
Effects of Front Kick-up Adjustment	29
Adjusting Front Kick-up	29
Anti-squat (Rear)	30
Effects of Rear Anti-squat Adjustment	30
Adjusting Rear Anti-squat	30
Wheelbase	31
Effects of Wheelbase Adjustment	31
Adjusting Wheelbase	31
Anti-roll Bars	32
Effects of Anti-roll Bar Adjustment	32
Adjusting Anti-roll Bars	32
Rear Wing	33
Effects of Rear Wing Adjustment	33
Adjusting the Rear Wing	33
Clutch	34
Clutch Springs	34
Clutch Shoe Orientation	34
Differentials	35
Differential Oil	35
Differential Gears	36
Optional Differentials (XRAY Active Diff™)	36
Gearing	37
Primary Drive Ratio	37
Gear Mesh Adjustment	37
Wheels, Tires and Inserts	37
Recommended Chemicals for Off-road Cars	39

Top-competition off-road cars/truggies are precision racing machines that feature multiple adjustments that allow you to set up for any track condition. Most modern off-road cars/truggies include innovative set-up features that allow you to change adjustments quickly to achieve a full range of adjustment.

The HUDY Off-road Set-up Book describes how to adjust your off-road car/truggy to suit your driving style. For each individual set-up area, we describe the effects of changing the adjustment and how to make the adjustment.

When setting up the car/truggy it is very important that the car sits on an ultra-flat surface. We strongly recommend using high-quality HUDY professional set-up tools – including an ultra-flat set-up board and marking decal – for every set-up adjustment.

The Basic Set-Up Sheet for your vehicle is always a very good overall starting point. After rebuilding the chassis, or in case you become lost with your set-up, always return to the basic starting set-up. If you choose to experiment with set-up, make small adjustments one at a time, and see if you find any improvement with each adjustment. We strongly advise you to record and keep track of your set-up changes, record which set-ups work best at different racetracks under various conditions.

If you own an XRAY model racing car then you can use blank XRAY Set-Up Sheets to record your data and set-ups or use the unique Virtual Online Database set-up sheets at www.teamxray.com where you can upload and share your set-up sheets or search for other set-up sheets posted by factory team drivers or search particular set-up for your track. The XRAY Virtual Online Database features thousands of set-up sheets and is the world's most unique set-up sheet source for your reference.

IMPORTANT!

The adjustment possibilities and methods of adjustment shown in this HUDY Off-road Set-up Book are particular to the XRAY XB808 1/8 off-road nitro buggy. The general theory behind the adjustments applies to all off-road vehicles, though the manner in which the measurements and adjustments are made may differ on other vehicles. Some of the off-road cars may not have possibility for some adjustments or may require use of some other optional parts to be able to perform some of the set-up adjustments. Always refer to the original manufacturer's documentation for explicit instructions on how to make set-up adjustments.

When setting up, operating and maintaining your off-road car or truggy, we strongly recommend using high-quality professional HUDY set-up equipment and tools.

SET-UP SYSTEM COMPONENTS

#108805 Exclusive Alu Set-Up System For All 1/8 Off-road Cars & Truggies

- CNC-machined alu. and acrylic components
- fully ball-bearing equipped
- precision engraving
- directly measures camber, camber rise, caster, toe, steering throw symmetry
- easy one-screw assembly/disassembly



#107703 Droop Gauge Support Blocks

- CNC-machined high-grade aluminum
- precision engraving
- supports chassis when checking downstops
- extra-high 30mm blocks for 1/8 off-road cars & truggies
- used with 107717 Droop Gauge



#107717 Droop Gauge

- CNC-machined high-grade aluminum
- precision engraving
- measures downstops for off-road vehicles when used 107703 Droop Gauge Support Blocks



#108202 Set-Up Board

- exceptionally flat, warp-resistant surface
- lightweight, easy to carry
- provides perfectly flat reference surface for chassis set-up
- must be used for any set-up adjustments



#108212 Set-Up Board Decal

- self-adhesive set-up decal for 108202 Set-Up Board
- accurate, clear markings for adjustment of 1/8 Off-road cars & truggies
- tough, smooth, liquid-resistant plastic surface
- used for track width adjustment and checking



#108860 Alu Nuts for Set-up System

- CNC-machined alu nuts for quick & easy attachment of set-up system plates to wheel axles



#108841 Truggy Upside Measure Plate

- CNC-machined upside measure plate (toe plate) for setting up 1/8 truggies
- made of high-quality, tough acrylic plastic
- precision engraved markings for instant, reliable readings
- used for the adjustment of: camber & camber rise, caster, front and rear toe, steering throw symmetry
- must be used with the #108805 Set-up System



TOOLS & EQUIPMENT

Turnbuckle Wrenches

- precision turnbuckle wrenches designed exclusively by HUDY from special self-developed, world-renown HUDY Spring Steel™ to ensure maximum strength, durability, and long life
- additionally hardened to provide unmatched life span
- wrench head shape is hand-ground on a precision grinding machine to ensure a very precise shape to a snug fit on the turnbuckle
- the fork end of the tool is additionally ground flat to keep the tool shape as thin as possible for very easy access in restricted areas
- available in 3 sizes: 3mm (#181030), 4mm (#181040), and 5mm (#181050)



HUDY Tools

- Allen 1.5 / 2.0 / 2.5mm (HUDY #111549 / #112049 / #112549)
- Phillips 5.0mm (HUDY #165049)
- Socket 5.0 / 5.5mm (HUDY #170058 / #170059)



#182010 Flywheel Tool

- CNC-machined professional Flywheel Tool off-road and on-road nitro vehicle clutches
- flywheel holder holds all modern RC nitro car flywheels with 2-to-4 pin designs, allowing you to loosen or tighten the flywheel nut very comfortably and easily.
- use with 107581 Wrench-Glowplug / Clutchnut to hold and loosen/tighten flywheel nuts quickly & easily
- other features (including clutch gap measurement, XCA-style clutchbell holder) for use with on-road XCA-style clutches



#107570 Wheel Nut Tool

- CNC-machined hardcoated tool for easy loosening/tightening 17mm wheel nuts on 1/8 off-road cars and truggies
- oversized handle gives superior torque
- robust design, machined from one piece
- hard anodized for extra-long lifespan



#107581 Wrench-Glowplug / Clutchnut

- unique, highly-useful combination tool for nitro racing includes the following:
- 10mm socket wrench for Centax type flywheel nut
- 8mm socket wrench for glowplug
- 5mm hex bit for suspension pivotballs
- extended 8mm glowplug wrench reaches glowplug even in deep cylinder heads
- made of world-renowned HUDY Spring Steel™ for highest strength and durability
- lightweight, perfect-fit tool
- laser-engraved for easy tool identification



#107610 Exhaust Spring/Caster Clip Remover

- designed to easily and quickly remove caster clips and exhaust springs
- tip from specially hardened steel
- very light non-slip duraluminum handle
- very durable, long life



#107600 Reamer For Lexan Bodies

- professional-quality reamer cuts perfect holes 0-18mm diameter
- exclusive design by HUDY
- very light non-slip duraluminum handle
- special CAD-designed cutting head, hand-ground on specially-modified production machinery
- perfect & comfortable cutting and use



Arm Reamer

- designed specifically for RC use, this arm reamer precisely resizes plastic holes without creating excessive slop, allowing you to build a perfect free-moving suspension
- comfortable molded handle
- quick & easy to use
- available for different size pins: 3.5mm pins (#107632), 3.0mm pins (#107633), 4.0mm pins (#107634).



#106000 Drive Pin Replacement Tool

- compact, rugged multi-use tool set for replacing 3mm drive pins in drive shafts
- heavy-duty construction for long life
- replacement pin sets available separately:
3x14 (#106050)
3x12 (#106051)
3x10 (#106052)



#104140 HUDY Engine Break-In Bench

- the ultimate tool for easy, safe, and professional break-in of your .12/.15/.21 engine
- suits all bump-start SG crank engines
- allows for a controlled break-in process that reduces wear & tear on engine components and increases performance, reliability, and longevity
- constructed of top-quality components of tough aluminum and spring steel
- comes partially assembled from the factory



ASSEMBLING AND INSTALLING THE SET-UP STANDS

When you are measuring and adjusting track-width, camber & camber rise, caster, toe, steering throw symmetry, and tweak, you will need to assemble and install the set-up stands.

When you are measuring downstops and ride height, you do not need to use the set-up stands.

ASSEMBLING THE SET-UP STANDS

The set-up stands of the Exclusive Alu. Set-Up System For All 1/8 Off-road Cars & Truggies must be assembled in order for you to use them. These stands were designed for quick and easy “one screw” assembly and disassembly

The set-up stands consist of the following pieces:

- alloy side plates front (2)
- alloy side plates rear (2)
- alloy camber gauges (4)
- acrylic toe gauge (1)

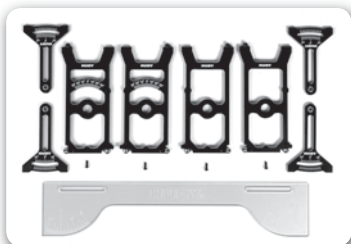

❶ Attach a camber gauge to a side plate using a screw through the ball-bearing at the top of the camber gauge.



❷ Using a 2.0mm Allen wrench, tighten the screw until snug.



❸ Make sure the stand operates freely without binding.



ASSEMBLING THE SET-UP BOARD

The completed set-up board consists of the Set-Up Board and the Set-Up Board Decal.

IMPORTANT:

You should always use only the HUDY set-up board when setting up your car with the HUDY All-In-One Set-Up Solution. This exceptionally flat, warp-free board will ensure accurate, precise measurements.

❶ Clean the board with a soft cloth to remove any debris or contaminants.



❷ Remove the paper from the rear of the decal, exposing the adhesive backing.



❸ Center the decal on the board, and then press the entire decal firmly onto the board.

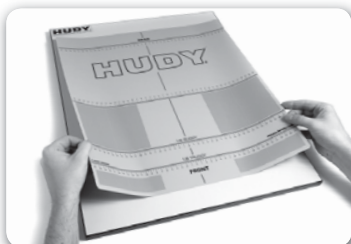

❹ Rub the decal until it is flat and completely adhered to the board.

INSTALLING THE SET-UP STANDS

After you have assembled the four set-up stands, mount them to your car as follows.

❶ Remove the wheels from the car. In place of the wheels, mount a set-up stand on each of the four axles. In front use side plates with scale, while in rear use side plates without scale (only with HUDY logo).

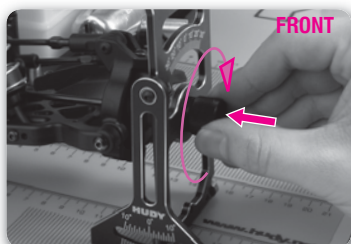

❷ The camber gauge of each stand should face outward so it is easy to read. The camber gauge of the front stand should face forward, while the camber gauge of the rear stand should face rearward.

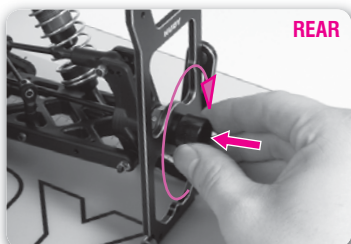

❸ Place the car (with the mounted set-up stands) on the set-up board.

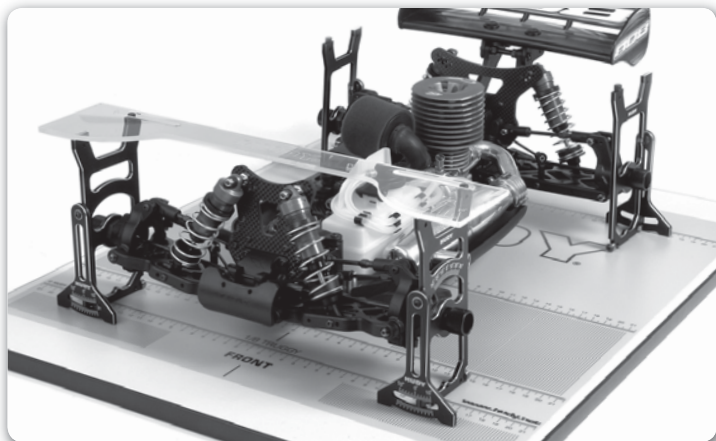

OVERVIEW OF CAR SET-UP

When setting up your off-road car/truggy, we recommend setting it up in the order indicated in the table below. The order of the settings has been determined as the most logical to set up your car/truggy properly and easily. Also, certain settings must be made before others, as changing one setting will impact another setting.

The table below also lists the set-up components to be used to measure or adjust a particular setting.

TO MEASURE OR ADJUST	USE
Downstops	<ul style="list-style-type: none">• Flat set-up board• Droop gauge support blocks• Droop gauge
Ride height	<ul style="list-style-type: none">• Flat set-up board• Droop gauge
Camber	<ul style="list-style-type: none">• Flat set-up board• Droop gauge support blocks• Assembled set-up stands
Track-width	<ul style="list-style-type: none">• Flat set-up board• Board decal
Caster	<ul style="list-style-type: none">• Flat set-up board• Assembled set-up stands
Toe	<ul style="list-style-type: none">• Flat set-up board• Droop gauge support blocks• Assembled set-up stands• Toe gauge

There are several types of suspensions used on RC cars, including pivotball and C-hub suspensions. Each suspension type has its own way of making adjustments for downstops, camber, caster, toe, etc. For detailed information on adjusting the settings on your car, refer to the appropriate set-up manuals for your car.

When setting up your off-road car/truggy, you should always prepare it so it is ready to run, though without the body. This means you should install all electronics, batteries, and fill the fuel tank (nitro only).

1.1 DOWNSTOPS

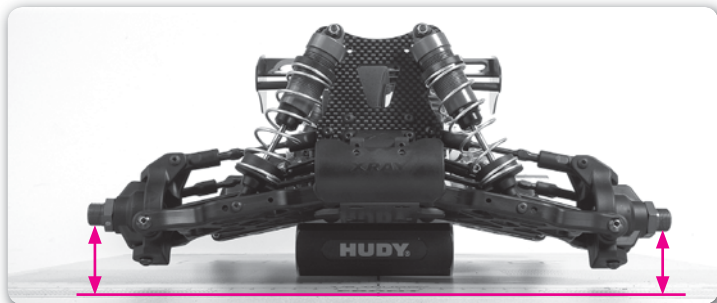

Downstops limit how far the suspension arms travel downward, which determines how far upward the chassis rises. This affects the car's handling (due to effects on camber and roll-center) and the ability of the tires to "follow" the track. The effects may change with the type of track and/or amount of grip available. Downstops are a very sensitive adjustment, since they alter weight transfer, and all aspects of chassis performance are affected: braking, acceleration, jumping, traction and rough track handling.

More suspension travel (lower downstop value) makes the car more responsive but less stable; it is also typically better on a bumpy track or on a track with slow corners. This allows the chassis to "pitch" rearward or forward more under acceleration or braking (respectively), which results in more weight transfer.

Less suspension travel (higher downstop value) makes the car more stable and is typically better on a smooth track. This prevents the chassis from "pitching" rearward or forward too much under acceleration or braking (respectively), which results in less weight transfer.

It is very important to have the same downstop settings on the left and right sides of the car.

EFFECTS OF DOWNSTOP ADJUSTMENT

FRONT DOWNSTOPS	
Higher downstop value (arm is higher, less travel)	<ul style="list-style-type: none">• Decreases front chassis upward travel on-throttle• Less rearward weight transfer• Better on smooth tracks• More on-power steering• More responsive in direction change
Lower downstop value (arm is lower, more travel)	<ul style="list-style-type: none">• Increases upward chassis travel on-throttle• More rearward weight transfer• Increases rear traction on corner exit• Better on bumpy tracks
REAR DOWNSTOPS	
Higher downstop value (arm is higher, less travel)	<ul style="list-style-type: none">• Decreases rear chassis upward travel off-throttle or under braking• Less forward weight transfer• Better on smooth tracks
Lower downstop value (arm is lower, more travel)	<ul style="list-style-type: none">• Increases rear chassis upward travel off-throttle or under braking• Less stable under braking• Increases steering on corner entry• Better on bumpy tracks• More turn-in

MEASURING DOWNSTOPS

INITIAL STEPS	SET-UP COMPONENTS
Prepare the car as follows	Use the following set-up components
<ul style="list-style-type: none">• Shocks: Attach the shocks• Anti-roll bars: Attach the anti-roll bars• Wheels: Remove the wheels	<ul style="list-style-type: none">• Droop Gauge Support Blocks #107703• Droop Gauge #107717• Set-up Board #108202

❶ Place the droop blocks on the flat set-up board, and then place the flat part of the chassis (not the angled part) on the blocks. Make sure the chassis is solidly mounted on the support blocks so it does not move.

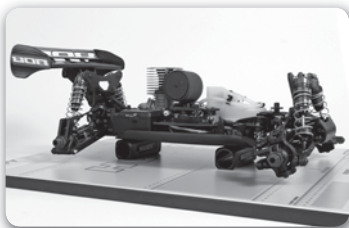

❷ Lift and drop the suspension arms so that they settle in their lowest positions.

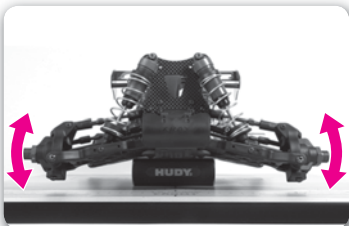

❸ Using the droop gauge, measure the downstop values at the front and rear of the car.

FRONT DOWNSTOPS:

Measure the front downstop values under the round part of the front wheel axles. DO NOT measure under the hex part.

The values shown on the droop gauge indicate how many millimeters the suspension drops below the level of the chassis.

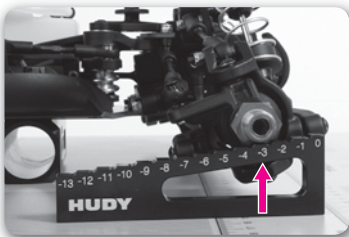

REAR DOWNSTOPS:

Measure the rear downstop values under the round part of the rear wheel axles. DO NOT measure under the hex part.

The values shown on the droop gauge indicate how many millimeters the suspension drops below the level of the chassis.

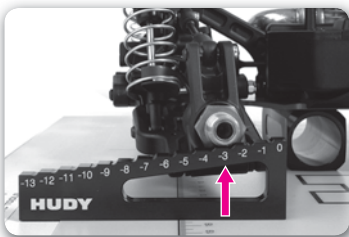

ADJUSTING DOWNSTOPS

FRONT DOWNSTOPS

Increase

Turn IN (or OUT) the front downstop screw (depending on the car design) so the front lower arm raises up slightly.

Decrease

Turn OUT (or IN) the front downstop screw (depending on the car design) so the front lower arm drops slightly.

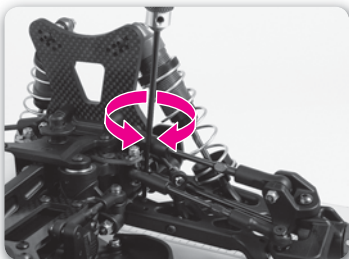

REAR DOWNSTOPS

Increase

Turn IN (or OUT) the rear downstop screw (depending on the car design) so the rear lower arm raises up slightly.

Decrease

Turn OUT (or IN) the rear downstop screw (depending on the car design) so the rear lower arm drops slightly.

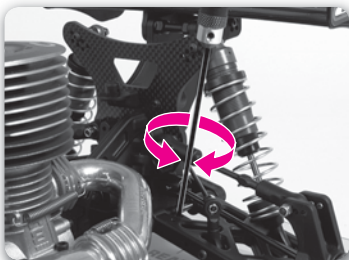

IMPORTANT!

Make equal adjustments on both left and right sides of the car.

1.2 RIDE HEIGHT

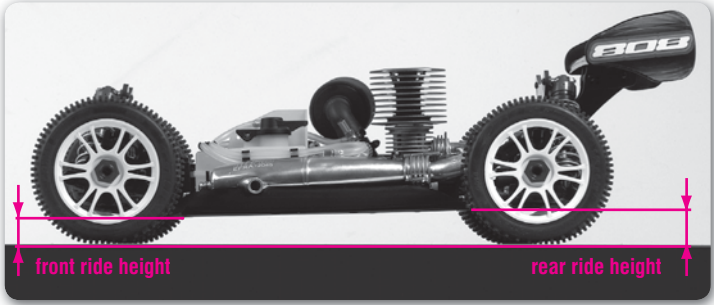

Ride height is the height of the chassis in relation to the surface it is sitting on, with the car ready to run. Ride height affects the car's traction since it alters the car's center of gravity and roll center. Differences in ride height alter the car's attitude (angle of the chassis) which in an off-road vehicle can effect how it jumps and lands. Because of changes in suspension geometry and ground clearance, there are negative consequences to altering ride height too much.

Ride height is measured with the wheels on the car, and the car ready-to-run. Use the shock preload collars or clips to raise and lower the ride height.

EFFECTS OF RIDE HEIGHT ADJUSTMENT

Decreasing ride height	<ul style="list-style-type: none">• Increases overall stability• Better on smooth tracks
Increasing ride height	<ul style="list-style-type: none">• Decreases overall stability• Better on bumpy tracks (prevents bottoming)
Front higher than rear	<ul style="list-style-type: none">• Increases weight transfer to the rear on-power• Increases stability• Decreases steering
Front lower than rear	<ul style="list-style-type: none">• Increases weight transfer to front off-power• Increases steering• Decreases rear traction• May cause car to nosedive off jumps

MEASURING RIDE HEIGHT

INITIAL STEPS	SET-UP COMPONENTS
Prepare the car as follows <ul style="list-style-type: none">• Shocks: Attach all shocks• Anti-roll bars: Attach all anti-roll bars• Wheels: Attach all wheels. Both left and right wheels at the front or rear should be the same diameter	Use the following set-up components <ul style="list-style-type: none">• Flat Set-up Board #108202• Droop Gauge #107717

- 1 Place the car on the set-up board.
- 2 Lift the front of the car and let it fall back to the set-up board by itself.
- 3 Using the droop gauge, measure the ride height value at the front of the car.

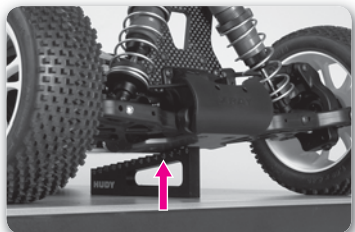
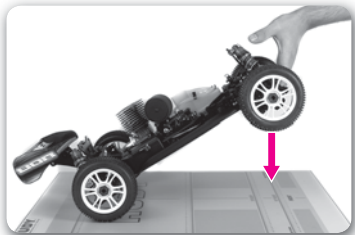

④ Lift the rear of the car and let it fall back to the set-up board by itself.



⑤ Using the droop gauge, measure the ride height value at the rear of the car.

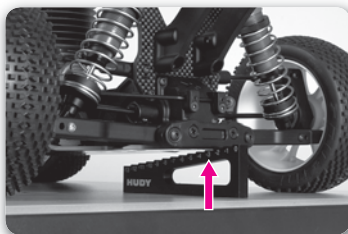

FRONT RIDE HEIGHT

Place the droop gauge under the front of the chassis (under the FLAT part of the chassis, not the angled part) and measure the difference between the set-up board and the bottom of the chassis.

The 0 mark on the droop gauge is equal to 30mm ride height. A negative value on the droop gauge is lower than the 30mm reference height. For example, if the chassis is at -3mm on the droop gauge, your ride height is $30-3\text{mm} = 27\text{mm}$.

REAR RIDE HEIGHT

Place the droop gauge under the rear of the chassis (under the FLAT part of the chassis) and measure the difference between the set-up board and the bottom of the chassis.

The 0 mark on the droop gauge is equal to 30mm ride height. A negative value on the droop gauge is lower than the 30mm reference height. For example, if the chassis is at -3mm on the droop gauge, your ride height is $30-3\text{mm} = 27\text{mm}$.

ADJUSTING RIDE HEIGHT

Adjust ride height using spring preload only; DO NOT adjust ride height using downstop screws.

Your car may use threaded spring preload collars or preload spacers.

Preload setting	Threaded preload collar	Preload spacers
Increase	TIGHTEN collar so it moves DOWN the shock body	Use THICKER spacers above the spring
Decrease	LOOSEN collar so it moves UP the shock body	Use THINNER spacers above spring

FRONT RIDE HEIGHT

Increase

INCREASE preload on both FRONT springs EQUALLY.

Decrease

DECREASE preload on both FRONT springs EQUALLY.

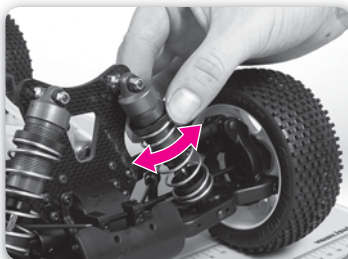

REAR RIDE HEIGHT

Increase

INCREASE preload on both REAR springs EQUALLY.

Decrease

DECREASE preload on both REAR springs EQUALLY.

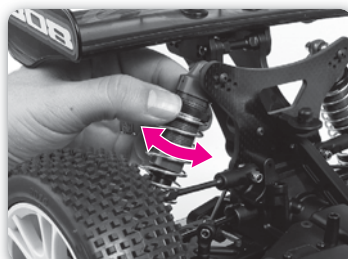

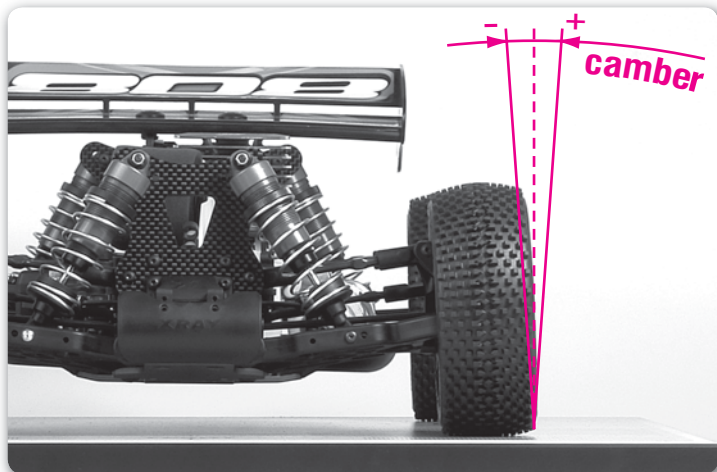

Camber is the angle of a wheel to the surface on which the car is resting (with wheels and shock absorbers mounted).

- Zero degrees (0°) of camber means that the wheel is perpendicular to the reference surface.
- Negative camber means that the top of the wheel is leaning inwards towards the centerline of the car.
- Positive camber means that the top of the wheel is leaning outwards from the centerline of the car.

Camber affects the car's side traction. Generally more negative (inward) camber means increased grip since the side-traction of the wheel increases. Adjust front camber so that the front tires wear flat. Adjust rear camber so that the rear tires wear slightly conical to the inside.

The amount of front camber required to maintain the maximum contact patch also depends on the amount of caster. Higher caster angles (more inclined) require less negative camber, while lower caster angles (more upright) require more negative camber.

EFFECTS OF CAMBER ADJUSTMENT

FRONT CAMBER	
More negative (more inclined)	• More steering
Less negative (less inclined)	• Less steering
REAR CAMBER	
More negative (more inclined)	• Decreases rear traction entering and in corners
Less negative (less inclined)	• Increases rear traction entering and in corners up to a point
	• If the shock is too vertical and traction is lost, the traction will be lost very abruptly and the car will be hard to control

MEASURING CAMBER

INITIAL STEPS	SET-UP COMPONENTS
Prepare the car as follows	Use the following set-up components
<ul style="list-style-type: none"> • Shocks: Attach all shocks • Anti-roll bars: Detach all anti-roll bars • Wheels: Remove all wheels 	<ul style="list-style-type: none"> • Flat Set-up Board #108202 • Assembled Set-up Stands #108805 • Droop Gauge Support Blocks #107703

- 1 Assemble the set-up stands.
- 2 Mount the set-up stands on the axles.
- 3 Place the droop blocks on the flat set-up board, and then place the flat part of the car chassis (not the angled part) on the blocks.

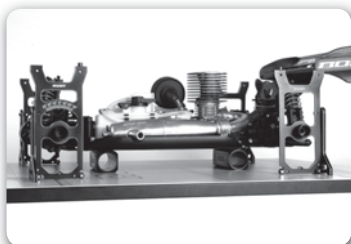

4 Push on the car so the chassis rests flat atop both droop blocks at front and rear.

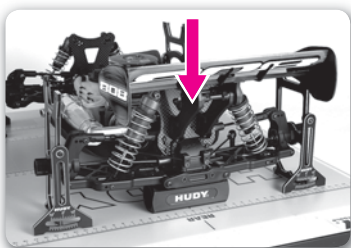

5 Read the camber setting from the camber gauge of each of the four set-up stands.

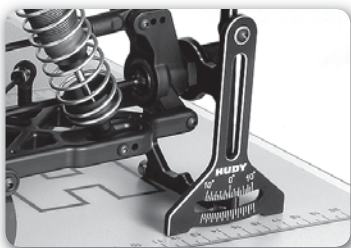

Each graduated mark indicates a 1° camber value. You should be able to set camber with a resolution of 0.5°.



ADJUSTING CAMBER

FRONT CAMBER

Increase (more -ve)

SHORTEN the front upper camber link.

Decrease (less -ve)

LENGTHEN the front upper camber link.

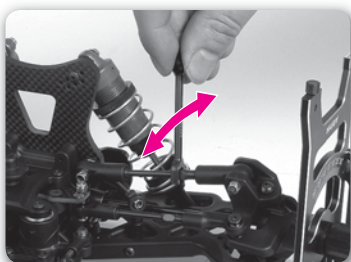

REAR CAMBER

Increase (more -ve)

SHORTEN the rear upper camber link.

Decrease (less -ve)

LENGTHEN the rear upper camber link

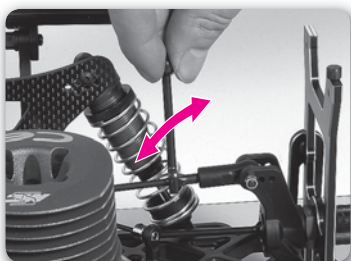

NOTE:

Changing the front camber will affect front toe. After setting the camber you must re-adjust the toe and then re-check the camber settings again. It may take a few repetitions of these steps to ensure that both camber and toe are set to the desired values.

1.4 TRACK-WIDTH

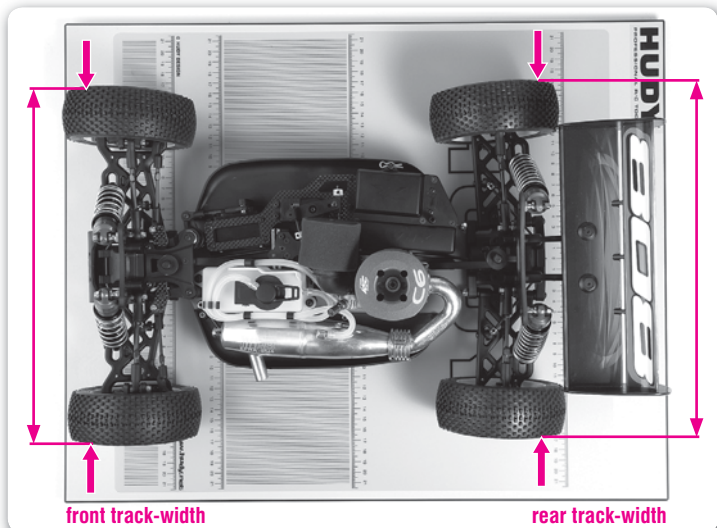

Track-width is the distance between the outside edges of the wheels, front or rear, and it affects the car's handling and steering response. It is important that front or rear track-width is adjusted symmetrically, meaning that the left and right wheels (at one end of the car) must be the same distance from the centerline of the chassis.

EFFECTS OF TRACK-WIDTH ADJUSTMENT

FRONT TRACK-WIDTH	
Wider	<ul style="list-style-type: none">• Decreases front grip• Increases understeer• Slower steering response• Use to avoid traction rolling
Narrower	<ul style="list-style-type: none">• Increases front grip• Decreases understeer• Faster steering response
REAR TRACK-WIDTH	
Wider	<ul style="list-style-type: none">• Increases rear grip at corner entry• Increases high-speed on-throttle steering• Use to avoid traction rolling
Narrower	<ul style="list-style-type: none">• Increases grip at corner exit• Increases high-speed understeer

MEASURING TRACK-WIDTH

INITIAL STEPS	SET-UP COMPONENTS
Prepare the car as follows <ul style="list-style-type: none">• Shocks: Attach all shocks• Wheels: Attach all wheels. Both left and right wheels at the front or rear should have the same offset	Use the following set-up components <ul style="list-style-type: none">• Flat Set-up Board #108202• Board Decal #108212

- 1 Place the car on the set-up board.
- 2 Align the center of the car with the centerline on the set-up board decal. Make sure both front and rear are centered on the decal.

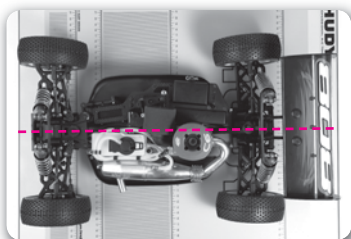

③ Make sure the front wheels rest on the front track-width graduation marks. The amount of toe-in/toe-out has direct influence on the track width so make sure to measure at the part where the car is widest.

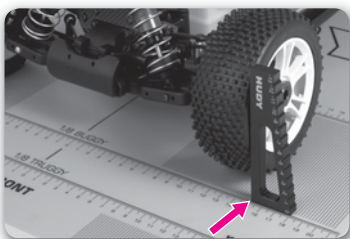

④ Make sure the rear wheels rest on the rear track-width graduation marks.

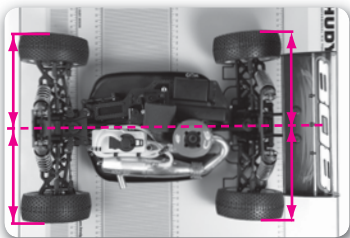

FRONT TRACK-WIDTH

Look where the outer edge of each front wheels lie on the front track-width graduation marks. Use a straight-edge against the wheel if necessary to see what the measurement is.

The measurement represents the distance from the car's centerline to the outer edge of each wheel.

For example, on a 308mm wide buggy car, the measurement should be close to 154mm ($\frac{1}{2}$ the track-width) for each wheel.

REAR TRACK-WIDTH

Look where the outer edge of each rear wheels lie on the front track-width graduation marks. Use a straight-edge against the wheel if necessary to see what the measurement is.

The measurement represents the distance from the car's centerline to the outer edge of each wheel.

For example, on a 306mm wide buggy car, the measurement should be close to 153mm ($\frac{1}{2}$ the track-width) for each wheel.

ADJUSTING TRACK-WIDTH

Different cars may use different methods for track-width adjustment.

C-HUB SUSPENSION

Normally you cannot adjust the track-width of a car with C-hub suspension due to the design of the suspension system. The suspension arms and other parts are designed to give you the correct track-width automatically. Optional off-set wheel axles may be offered to adjust track-width.



PIVOTBALL SUSPENSION

Cars with adjustable pivotball-style suspension can change track-width by adjusting the pivotballs into or out of the suspension arms.

IMPORTANT!

Make equal adjustments on both left and right sides of the car.

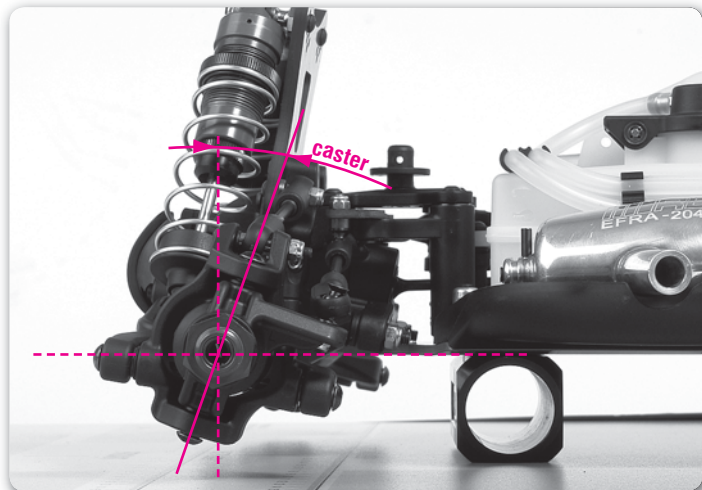

Caster describes the angle of the front steering block with respect to a line perpendicular to the ground. The primary purpose of having caster is to have a self-centering steering system. Caster angle affects on- and off-power steering, as it tilts the chassis more or less depending on how much caster is applied.

For the purpose of RC cars, it is generally recommended that you use a steeper caster angle (more vertical) on slippery, inconsistent and rough surfaces, and use a shallower caster angle (more inclined) on smooth, high-grip surfaces.

CAMBER vs. CASTER

Camber is all about contact patch – keeping as much tire on the ground as possible. Camber and caster are related in that caster can afford an amount of EFFECTIVE CAMBER change when the front wheels are turned in a corner.

Caster has the effect of progressively leaning the front tires into the direction of the corner. The more the caster angle is laid-back, the greater the effective camber change when the wheels are turned. This happens because the tops of the wheels BOTH TILT towards the inside of the corner; the wheels “dig in” more, counteracting the centrifugal forces pushing the car to the outside.

Compare that to the static camber of the wheels, which is adjusted with the car sitting on a level surface and the wheels pointed straight ahead. Static camber adjustments primarily affect the outside wheels, since these are the wheels that bear the majority of the load during cornering.

Hence, the amount of front camber required to maintain maximum tire contact largely depends on the amount of caster. A steeper caster angle requires more camber, while a shallower caster angle requires less camber.

TOTAL CASTER ANGLE

Total caster angle also depends on the front kick-up angle.

To determine the total caster angle, combine the kick-up angle + C-hub caster angle.

Example: 10° front kick-up + 10° caster in C-hub = 20° total caster

EFFECTS OF CASTER ADJUSTMENT

Less caster angle (more vertical)	<ul style="list-style-type: none"> • Decreases straight-line stability • Increases off-power steering at corner entry • Increases suspension efficiency
More caster angle (more inclined)	<ul style="list-style-type: none"> • Increases straight-line stability • Decreases off-power steering at corner entry • Makes the car more stable through bumpy track conditions

MEASURING FRONT CASTER

INITIAL STEPS	SET-UP COMPONENTS
Prepare the car as follows <ul style="list-style-type: none"> • Shocks: Attach all shocks • Wheels: Remove all wheels 	Use the following set-up components <ul style="list-style-type: none"> • Flat Set-up Board #108202 • Assembled Set-up Stands #108805

- 1 Assemble the set-up stands.
- 2 Mount the set-up stands on the axles.
- 3 Place the car on the set-up board.

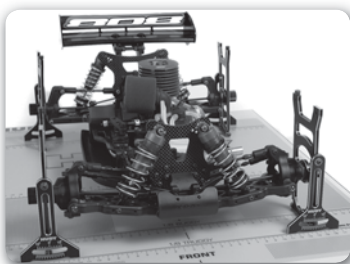

- 4 Read the caster angle from the side of the front set-up stands.

Read the caster angle on the side plates between the imaginary line that goes from the top pivot point to the bottom pivot point. Each graduated mark indicates a 2° camber value. You should be able to set camber with a resolution of 1°.

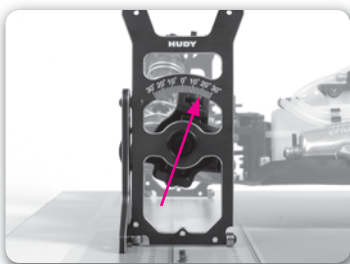

ADJUSTING FRONT CASTER

There are several different ways to adjust caster on a car with C-hub suspension, depending on the design of the car:

- Non-adjustable C-hubs (for example, XB808): change to C-hubs of different caster values
- Adjustable C-hubs (for example, XB8EC): change the C-hub eccentric pin holder.



IMPORTANT!

Make equal adjustments on both left and right sides of the car.

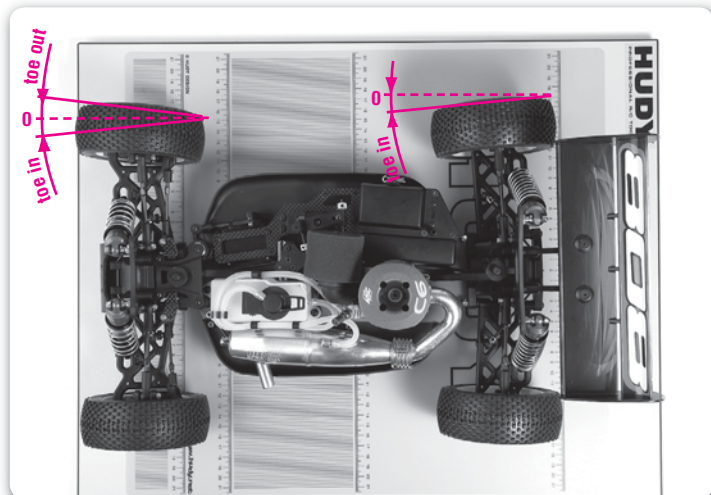

Toe is the angle of the wheels when looked at from above the car. Toe is used to stabilize the car at the expense of traction, as it introduces friction and therefore some slip in the tires.

- When the wheels are parallel with the centerline of the car, toe is 0° (neutral).
- When the wheels are closed towards the front, this is called toe-in (positive value).
- When the wheels are open towards the front, this is called toe-out (negative value).

Front wheels can have either toe-in or toe-out.

Rear wheels should always have toe-in; they should never have toe-out.

Toe may be adjustable at either end of a suspension arm:

- Inboard toe (if available) is typically adjusted by altering the angle of the suspension arm's inner pivot pin. Inboard toe adjustment is not available on all vehicles.
- Outboard toe (if available) may be adjusted in two ways: at the front by adjusting the lengths of the steering rods; at the rear by altering the angle of the suspension arms inner mounting pin (or other method)

EFFECTS OF TOE ADJUSTMENT

FRONT TOE	
Increasing (more toe-in)	<ul style="list-style-type: none"> • Makes car easier to drive
Decreasing (less toe-in, or more toe-out)	<ul style="list-style-type: none"> • Decreases understeer • Increases steering at corner entry • Faster steering response • Less stable under acceleration • Makes car more difficult to drive
REAR TOE	
Increasing (more toe-in)	<ul style="list-style-type: none"> • Increases understeer • More stable exiting on-power at corner exit and braking • Less chance of losing rear traction • Decreases top speed
Decreasing (less toe-in)	<ul style="list-style-type: none"> • Less stable at on-power corner exit and braking • More chance of losing rear traction • Increases top speed

MEASURING TOE

INITIAL STEPS	SET-UP COMPONENTS:
Prepare the car as follows:	Use the following set-up components:
<ul style="list-style-type: none"> • Shocks: Attach all shocks • Wheels: Remove all wheels 	<ul style="list-style-type: none"> • Flat Set-up Board #108202 • Assembled Set-up Stands #108805 • Toe Gauge (for Truggy #108841) • Droop Gauge Support Blocks #107703

When using the acrylic toe gauge, the toe gauge does not fit over the pins on the set-up stands so that the toe gauge is in one position. The toe gauge is designed to slide over the pins from one side to the other, depending on which wheel you are measuring (left or right). Follow the instructions carefully.

- ❶ Assemble the set-up stands.
- ❷ Mount the set-up stands on the axles.
- ❸ Place the droop blocks on the flat set-up board, and then place the flat part of the car chassis (not the angled part) on the blocks.
- ❹ Push on the car so the chassis sits flat atop both droop gauges at front and rear.
- ❺ Place the toe plate atop the stands and measure the toe value.

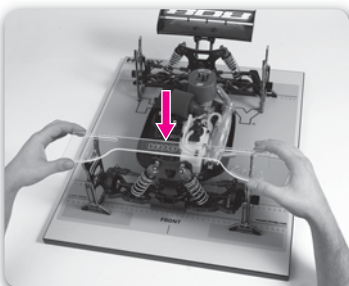
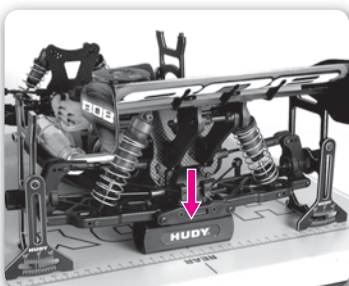

FRONT TOE

Set the toe gauge atop the front set-up stands. The pins at the top of the stands fit in the machined slots in the toe gauge. Set the steering trim on your servo & transmitter so that the front wheels point directly forward. Set the steering in the neutral position using the transmitter. Turn on the car & transmitter when setting front toe so the front wheels point straight ahead.

Push on the car so the chassis sits flat atop both droop gauges at front and rear.

To read the toe value of the left front wheel, push the toe gauge to the right until the pin on the top edge of the left set-up stand hits the edge of the slot in the toe gauge. Now read the toe value on the toe gauge. The black line on the top edge of the stand points to a toe value engraved in the toe gauge. Each graduated mark indicates a 1° toe value. You should be able to set toe with a resolution of 0.5°.

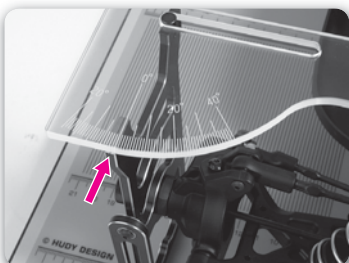

To read the toe value of the right front wheel, push the toe gauge to the left until the pin on the top edge of the right set-up stand hits the edge of the slot in the toe gauge. Read the measurement.

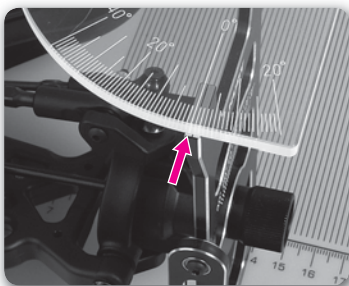

REAR TOE

Set the toe gauge atop the rear set-up stands. The pins at the top of the stands fit in the machined slots in the toe gauge.

Push on the car so the chassis sits flat atop both droop gauges at front and rear.

To read the toe value of the left rear wheel, push the toe gauge to the right until the pin on the top edge of the left set-up stand hits the edge of the slot in the toe gauge. Now read the toe value on the toe gauge. The black line on the top edge of the stand points to a toe value engraved in the toe

gauge. Each graduated mark indicates a 1° toe value. You should be able to set toe with a resolution of 0.5°.

To read the toe value of the right rear wheel, push the toe gauge to the left until the pin on the top edge of the right set-up stand hits the edge of the slot in the toe gauge. Read the measurement.

ADJUSTING TOE

FRONT TOE

Increase (more front toe-in)
LENGTHEN both front steering rods
EQUALLY.

Decrease (less front toe-in)
SHORTEN both front steering rods
EQUALLY

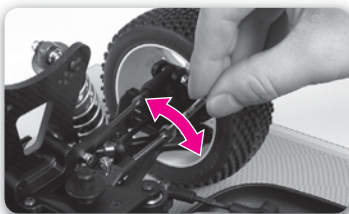

REAR TOE

Refer to your car's instruction manual for more information about changing rear toe in. Different cars use different methods to adjust rear toe-in usually changing toe-in blocks. Refer to your car's instruction manual for more information.



NOTE:

Changing the front camber will affect front toe. After setting the camber you must re-adjust the toe and then re-check the camber settings again. It may take a few repetitions of these steps to ensure that both camber and toe are set to the desired values.

1.7 STEERING



Steering systems may be adjustable for Ackermann angle, servo saver preload, and bump steer.

1.7.1 ACKERMANN

Ackermann controls the difference in steering arcs between the front inside and outside wheels; the inside wheel always has a tighter arc in any corner. The amount of grip provided by the tires, in relation to the steering arc and speed of the car, create an amount of measurement called a “slip angle” for each wheel. For some tires you need a greater difference in slip angles between the inner and outer wheel and for some you need less.

The servo saver on off-road cars & truggies forces the inside wheel to increase its turning angle at a greater rate than the outside wheel, as the servo turns either way from center. The rate of the increase, called Ackermann effect, can be changed by the angle of the steering rods connecting the steering plate. The straighter the rods are in relation to each other, the more Ackermann effect will be applied to the inside wheel

EFFECTS OF ACKERMANN ADJUSTMENT

STEERING ROD INNER MOUNTING POSITION	CHARACTERISTICS
Forward holes (sharper angle)	<ul style="list-style-type: none">• Smoothens out steering response• Car reacts smoothly• Better suited to smooth flowing tracks with high speed corners
Rearward holes (shallower angle)	<ul style="list-style-type: none">• Quickens initial steering response• Car reacts faster to steering input• Better suited to small, tight tracks

ADJUSTING ACKERMANN



Adjust the Ackermann angle by moving the inside ends of the steering rods into different holes in the steering plate.

IMPORTANT!

After adjusting the Ackermann, recheck that your front toe setting is still correct.

1.7.2 SERVO SAVER PRELOAD

On cars equipped with an adjustable steering servo server, you may adjust the spring preload to alter the steering characteristics.

EFFECTS OF SERVO SAVER PRELOAD

SERVO SAVER SPRING PRELOAD	CHARACTERISTICS
Softer	<ul style="list-style-type: none">• Less steering• Better suited to standard servos
Stiffer	<ul style="list-style-type: none">• More steering with a quicker reaction• Better suited to high torque metal-gear servos

ADJUSTING SERVO SAVER PRELOAD

Adjust the preload of the central servo saver by adjusting the tension on the spring with the threaded collar.

- To make the preload SOFTER, loosen the collar so the spring is not compressed as much.
- To make the preload STIFFER, tighten the collar so the spring is compressed more.

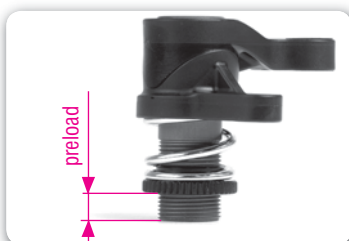

1.7.3 BUMP STEER

Bump steer is a front suspension tuning option commonly used in off-road RC racing to change steering characteristics over rough and loose terrain. Bump steer occurs when a car's front toe angle changes as the suspension compresses or rebounds, which affects how parallel the front wheels are.

EFFECTS OF BUMP STEER

More bump steer (wheels more parallel under compression)	<ul style="list-style-type: none">• Increases steering in mid-corner• Steering may become "twitchy"• Easier to control on smooth tracks
Less bump steer (wheels open more under compression)	<ul style="list-style-type: none">• Decreases steering in mid-corner• Smoother steering response• Better on rough or bumpy tracks

ADJUSTING BUMP STEER

Bump steer is adjusted differently on every car. Please refer to the car's documentation to determine how to make adjustments.

The following table describes how to adjust bump steer on an XRAY XB808, using shims below the steering plate (between the steering rod inner ends and the bottom of the steering plate).

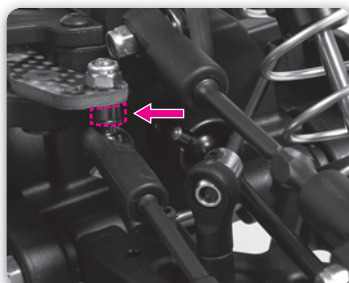

More bump steer	<ul style="list-style-type: none">• Fewer/thinner shims below steering plate• Steering rod becomes more angled (away from horizontal)
Less bump steer	<ul style="list-style-type: none">• More/thicker shims below steering plate*• Steering rod becomes more horizontal

* Remember that you can add more shims to get less bump steer, but only up to a certain point (when the steering rods become horizontal). If you continue to add more shims the steering rod will become more angled the other way (as the inner end moves further away from the steering plate), and you will start to get more bump steer again.

IMPORTANT!

Make equal adjustments on both left and right sides of the car.

1.8 ROLL CENTER

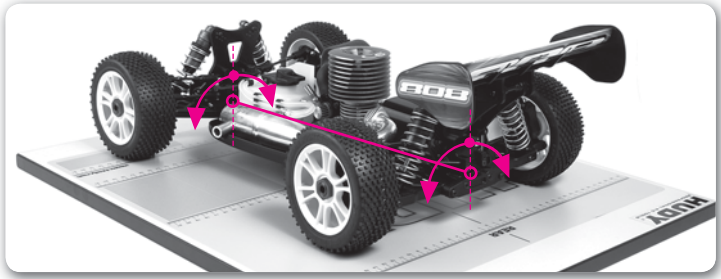

A “roll center” is a theoretical point around which the chassis rolls, and is determined by the design of the suspension. Front and rear suspensions normally have different roll centers. The “roll axis” is the imaginary line between the front and rear roll centers. The amount that a chassis rolls in a corner depends on the position of the roll axis relative to the car’s center-of-gravity (CG). The closer the roll axis is to the center of gravity, the less the chassis will roll in a corner. A lower roll center will generally produce more grip due to the chassis rolling, and the outer wheel “digging in” more. Roll-centers have an immediate effect on a car’s handling, whereas anti-roll bars, shocks and springs require the car to roll before they produce an effect.

Roll center is determined by the car’s suspension geometry. Each end of the car has its own roll center, determined by the suspension geometry at that end of the car.

Depending on the car, front and rear roll center may be adjusted by raising or lowering a variety of different pivot points of the suspension arms & blocks, such as the following:

- inner upper pin/link
- outer upper pin/link
- inner lower pin
- outer lower pin

For information on adjusting roll center on cars with other adjustment possibilities (for example, outer lower pins) please refer to the manufacturer’s original detailed documentation.

1.8.1 FRONT ROLL CENTER

Typically on off-road cars (such as the XRAY XB808) front roll center is adjusted using the front upper camber link inner mounting position on the front shock tower. Those same holes on the front shock tower may also be used to adjust camber rise. For more information, see the section on Camber & Camber Rise.

For information on adjusting front roll center on cars with other adjustment possibilities (for example, the outer lower pin) please refer to the manufacturer’s original detailed documentation.

EFFECTS OF FRONT ROLL CENTER ADJUSTMENT

FRONT UPPER CAMBER LINK - SHOCKTOWER	EFFECT ON FRONT ROLL CENTER
Upper holes (lower roll center)	<ul style="list-style-type: none">• Increases steering into corner• Car is more responsive
Lower holes (higher roll center)	<ul style="list-style-type: none">• Decreases steering into corner• Car is less responsive• Use in high-grip conditions

ADJUSTING FRONT ROLL CENTER

Front roll center is typically adjusted by changing where the inner end of the front upper camber link attaches to the front shock tower.



IMPORTANT!

Make equal adjustments on both left and right sides of the car. Recheck front camber after adjusting front roll center.

1.8.2 REAR ROLL CENTER

Typically on off-road cars (such as the XRAY XB808) rear roll center is adjusted using the rear upper camber link inner mounting position on the rear shock tower. Those same holes on the rear shock tower may also be used to adjust camber rise. For more information, see the section on Camber & Camber Rise.

For information on adjusting rear roll center on cars with other adjustment possibilities (for example, the outer lower pin) please refer to the manufacturer's original detailed documentation.

EFFECTS OF REAR ROLL CENTER ADJUSTMENT

REAR UPPER CAMBER LINK - SHOCKTOWER	EFFECT ON REAR ROLL CENTER
Upper holes	• Lower rear roll center
Lower holes	• Higher rear roll center

REAR UPPER CAMBER LINK - LENGTH	CHARACTERISTICS
Shorter link (outer hole on tower and/or inner hole on hub)	• Increases steering and decreases stability into corner • Increases on-power traction slightly
Longer link (inner hole on tower and/or outer hole on hub)	• Decreases rear camber gain • Increases stability • Slows down the car's responsiveness

REAR ROLL CENTER	CHARACTERISTICS
Higher	• Increases on-power traction • Use to avoid traction rolling at corner entry • Use under low-traction conditions
Lower	• Decreases rear traction into corner • Increases steering into corner • Use to avoid traction rolling mid-corner and corner exit

ADJUSTING REAR ROLL CENTER

Use the mounting positions of the rear upper camber link to adjust rear roll center.

Inner mounting position:

- The inner end of the rear upper camber link can be attached to the rear shock tower in several different positions.

Outer mounting position:

- The outer end of the rear upper camber link can be attached to the rear hub in one of several positions.

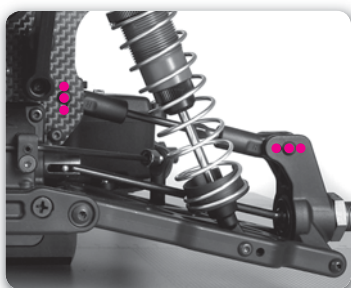

IMPORTANT!

Make equal adjustments on both left and right sides of the car. Recheck rear camber after adjusting rear roll center.

1.9 SHOCK ABSORBERS

Shock absorbers, or shocks, are the suspension components that allow the wheels to keep as much contact as possible with the track surface. All off-road cars & truggies have fully-independent front and rear suspension, meaning that the suspension at each corner of the car (front left, front right, rear left, rear right) moves and may be adjusted independently of the others. As such, there is a shock absorber at each corner of the car. Damping, mounting position, spring tension, and spring preload are all characteristics that determine how the shock performs.



1.9.1 SHOCK DAMPING

Shock damping manages the resistance of the shock to movement, as the internal shock piston moves through the shock oil when the shock compresses and rebounds. Damping mainly has an effect on how the car behaves on bumps and jumps, and how it reacts initially to steering, braking, and acceleration.

Damping only comes into play when the suspension is moving (either vertical wheel or chassis movement or due to chassis roll), and loses its effect when the suspension has reached a stable position. Without damping, the shock springs would cause the shock to “pogo” or “bounce” (compressing and rebounding) until it stabilized.

When the shock is compressing or rebounding, the shock oil resists the movement of the piston through it. The amount of resistance is affected by several factors:

- Viscosity (thickness) of the shock oil
- Restriction of oil flow through the piston (affected by the number of holes in the piston and the hole diameter)
- Velocity (speed) of the piston

Damping is affected by both shock oil and shock piston settings; getting the optimum shock damping typically requires a lot of “hands on” experience.

EFFECTS OF SHOCK DAMPING

The effects of damping are often difficult to distinguish since there is an adjustment where grip is optimum. When you get away from the optimum damping setting, either softer or harder, the car will always lose grip.

The table below describes the handling effects by changing damping on one end of the car; the starting point is always the ideal “optimum.”

		ADJUSTING WITH...		EFFECT
		SHOCK OIL	PISTON HOLES	
Front Shocks				
Softer Damping	Thinner	More holes/ Larger holes	<ul style="list-style-type: none">• Increases steering on low grip surface• Slower steering response• Decreases initial steering at corner entry• Increases oversteer at corner exit/under acceleration	
Harder Damping	Thicker	Less holes / Smaller holes	<ul style="list-style-type: none">• Faster steering response• Decreases steering on low grip• Increases initial steering at corner entry• Increases understeer at corner exit/under acceleration	
Rear Shocks				
Softer Damping	Thinner	More holes/ Larger holes	<ul style="list-style-type: none">• Increases rear grip at corner exit/under acceleration	
Harder Damping	Thicker	Less holes / Smaller holes	<ul style="list-style-type: none">• Decreases rear grip at corner exit/under acceleration	

SHOCK PISTONS

Typically, shock pistons are provided with different sizes of the holes. The sizes or number of holes affect shock damping by altering the flow of oil through the holes.

- More holes or larger holes give softer damping
- Fewer holes or smaller holes give harder damping



Different size holes also produce an effect known as “pack” which affects how quickly the shocks respond.

- Smaller holes increase the pack of the shock, which is better suited to big-jump tracks where you will often land on the flat surface & not the down ramp side of the jump. It slows things on compression and rebound, and is not well suited to very bumpy tracks.
- Larger holes decrease the pack of the shock, which is better suited to bumpy tracks and jump sections where you land on the down ramp side of the jump. Compression and rebound are faster.

IMPORTANT!

Both front shocks should use the same pistons; both rear shocks should use the same pistons. However, front & rear shock pairs may use different pistons.

SHOCK OIL

Shock oil is rated with a “viscosity” number that indicates the thickness of the oil, which determines how much the oil resists flowing and how much it resists the shock piston moving through it. Shock oil with a higher viscosity (for example, 1000 cSt) is thicker than shock oil with a lower viscosity (for example, 500 cSt).

We recommend using only highest-grade XRAY Silicone Oil, which is available in numerous viscosities. XRAY Silicone Shock Oil is specially formulated to be temperature-resistant and low-foaming for use in XRAY shocks. To be able to compare your setup with other XRAY drivers, we advise using only XRAY Silicone Shock Oil.

Note that typically you should use piston hole sizes to suit the track conditions rather than alter the oil viscosity.

IMPORTANT!

Both front shocks should use the same oil; both rear shocks should use the same oil. However, front & rear shock pairs may use different pistons.

XRAY PREMIUM SILICONE OIL					
# 359210	100 cSt		# 359245	450 cSt	
# 359215	150 cSt		# 359250	500 cSt	
# 359220	200 cSt		# 359260	600 cSt	
# 359225	250 cSt		# 359270	700 cSt	
# 359230	300 cSt		# 359280	800 cSt	
# 359235	350 cSt		# 359290	900 cSt	
# 359240	400 cSt		# 359301	1 000 cSt	

SHOCK SPRINGS

Spring tension determines how much the spring resists compression, which is commonly referred to as the “hardness” of the spring. Different spring tensions determine how much of the car’s weight is transferred to the wheel relative to the other shocks. Spring tension also influences the speed at which a shock rebounds after compression.



Spring tension is usually rated in a “spring weight” ; higher spring weights are stiffer, while lower spring weights are softer.

IMPORTANT!

Both front shocks should use the same springs; both rear shocks should use the same springs. However, front & rear shock pairs may use different springs.

EFFECTS OF SHOCK SPRING REPLACEMENT

SHOCK SPRING	CHARACTERISTICS
Softer	<ul style="list-style-type: none"> • More chassis roll • More traction • Better on bumpy tracks • Increases chance of bottoming out when landing
Stiffer	<ul style="list-style-type: none"> • Less chassis roll • Less traction • More responsive • Better on smooth tracks • Decreases chance of bottoming out when landing

1.9.3 SHOCK MOUNTING POSITION

You can change the shock mounting position by leaning the shocks at different angles, and also moving the shock closer or further from the centerline of the car.



EFFECTS OF SHOCK MOUNTING POSITION ADJUSTMENT

SHOCK POSITION	CHARACTERISTICS
More inclined (moving in on tower and/or moving out on lower arm)	<ul style="list-style-type: none"> • Softer initial damping • More progressive damping • More lateral (side) traction • Makes the handling more "forgiving" • May be better on high-bite tracks, since it slows down the handling and makes it easier to driver
Less inclined (moving out on tower and/or moving in on lower arm)	<ul style="list-style-type: none"> • Harder damping • Less lateral (side) traction • Makes the car more responsive • Usually better suited on technical tracks

SHOCK UPPER POSITION (SHOCK TOWER)

Front Shock Tower	Outer holes	<ul style="list-style-type: none"> • Faster steering • Better on bumps and jumps
	Inner holes	<ul style="list-style-type: none"> • Easier to drive • More side bite • Slower initial steering
Rear Shock Tower	Outer holes	<ul style="list-style-type: none"> • Less mid corner grip • More traction into corner • Squares up better on exit
	Inner holes	<ul style="list-style-type: none"> • More steering into corner • More mid corner grip

SHOCK LOWER POSITION (ARM)

Front Arm	Outer holes	<ul style="list-style-type: none"> • Increases stability • Easier to drive • Bigger turn radius
	Inner holes	<ul style="list-style-type: none"> • Faster steering • Better for bumps and jumps
Rear Arm	Outer holes	<ul style="list-style-type: none"> • More stability • More lateral grip in turns
	Inner holes	<ul style="list-style-type: none"> • Better for bumps and jumps • Less side bite • More exit traction

ADJUSTING SHOCK MOUNTING POSITION

Adjust shock position by moving the shock top and bottom mounts to different locations on the shock towers and lower arms.

1.9.4 SHOCK PRELOAD

Shock preload affects the ride height of the car. For more information, see the section on Ride Height.

EFFECTS OF SHOCK PRELOAD ADJUSTMENT

SHOCK PRELOAD	CHARACTERISTICS
Less preload (thinner/less spacers)	<ul style="list-style-type: none"> • Lower ride height • May give higher corner speed on high bite tracks • Better suited to smooth tracks
More preload (thicker/more spacers)	<ul style="list-style-type: none"> • Higher ride height • Less prone to bottoming out • Better suited to rough tracks

ADJUSTING SHOCK PRELOAD

Adjust the front and rear shock spring preload by using preload clips of various thicknesses above the shock springs, or by adjusting the height of threaded preload adjustment collars.

Initial set front preload so that the front and drive shafts are level, and initially set rear preload so that the rear lower arms are level. You can then adjust front and/or rear preload to suit track conditions & requirements.

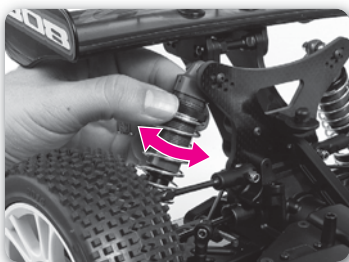

IMPORTANT!

Both front shocks should have the same preload; both rear shocks should have the same preload. However, front & rear shock pairs may use different preload.

1-10 KICK-UP (FRONT)

Front kick-up is the angle of the front lower suspension arm when viewed from the side of the car. With kick-up the front of the arm is higher than the rear of the arm. Kick-up may be built into the design of the chassis plate (bend upwards at the front) or it may be accomplished by altering the angle of the front lower inner pivot pins.

Front kick-up is used to adjust the amount of weight transfer to the front when the car is off-throttle or under braking.

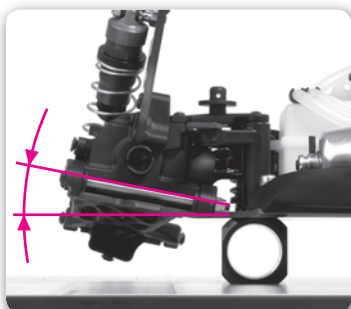

EFFECTS OF FRONT KICK-UP ADJUSTMENT

FRONT KICK-UP ANGLE	CHARACTERISTICS
More kick-up	<ul style="list-style-type: none">• More weight transfer to the front of the chassis off-throttle or under braking• Chassis compresses or drops more off-throttle or under braking• Handling is improved on bumpy tracks• Decreased steering response
Less kick-up	<ul style="list-style-type: none">• Less weight transfer to the front of the chassis off-throttle or under braking• Chassis compresses or drops less off-throttle or under braking• Handling is improved on smooth tracks• Increased steering response

ADJUSTING FRONT KICK-UP

Some vehicles (like the XB808) have fixed front kick-up, though optional parts may be available to allow adjustment. When front kick-up is adjustable, it is typically adjusted via adjustable holders for the front lower inner pivot pin.



IMPORTANT!

Make equal adjustments on both left and right sides of the car.

1.11 ANTI-SQUAT (REAR)

Rear anti-squat is the angle of the rear lower suspension arm when viewed from the side of the car. With anti-squat the back of the arm is lower than the front of the arm.

Rear anti-squat is used as a tuning aid primarily when a car needs to run a soft rear spring but also has a tendency for the rear end to squat down too much under acceleration. An added benefit of rear anti-squat is quicker initial acceleration at the start of a race.

In order to prevent 100% of the car's weight transfer force from being exerted onto the soft rear springs, anti-squat is used to allow a certain percentage of the weight transfer to be absorbed by the rear lower arm motion.

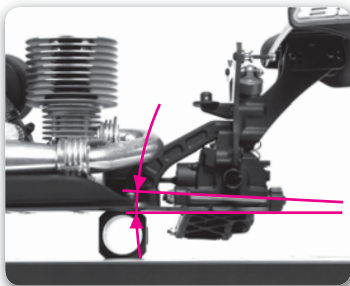

EFFECTS OF REAR ANTI-SQUAT ADJUSTMENT

REAR ANTI-SQUAT ANGLE	CHARACTERISTICS
Less anti-squat (flatter arm)	<ul style="list-style-type: none">• Increases rear traction off-power• Decreases rear traction on-power• Better on a bumpy track
More anti-squat (leaning more backwards)	<ul style="list-style-type: none">• Increases rear traction during acceleration• Decreases rear traction off-power• Better on smooth high grip tracks

ADJUSTING REAR ANTI-SQUAT

Some vehicles (like the XB808) have fixed rear anti-squat, though optional parts may be available to allow adjustment. When rear anti-squat is adjustable, it is typically adjusted via eccentric holders for the rear lower inner pivot pin.



IMPORTANT!

Make equal adjustments on both left and right sides of the car.

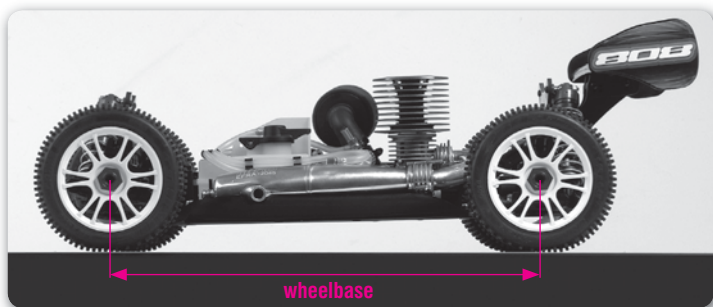

Wheelbase refers to the horizontal distance between the front and rear axles. Changes to wheelbase can have a dramatic effect on the handling of your car, since it readjusts the distribution of weight on the wheels, which adjusts traction. Not all RC cars have the option to adjust the wheelbase.

By adjusting the wheelbase at one end of the car, you affect the traction at that end of the car. For example, by shortening the wheelbase at the rear of the car, you place more weight over the rear wheels (resulting in more rear traction).

EFFECTS OF WHEELBASE ADJUSTMENT

WHEELBASE	CHARACTERISTICS
Shorter wheelbase (less spacers in front of rear upright)	<ul style="list-style-type: none"> • Increases rearward weight transfer during acceleration • Increases on-power traction • Quicker off-power steering into corners • Slight tendency to push on-power at corner exit • Increases steering response • Better on tighter, more technical tracks
Longer wheelbase (more spacers in front of rear upright)	<ul style="list-style-type: none"> • Decreases off-power steering into sharp corners • Increases stability • Slower initial steering reaction (off-power) • Improves on-power steering at corner exit • Better handling over bumps and ruts • Better on more open tracks with high-speed corners

ADJUSTING WHEELBASE

Depending on the car, wheelbase may be adjusted by using shims in the following locations:

- Front and rear lower inner pivot pins, ahead of & behind the front and rear lower suspension arms
- Rear lower outer pivot pins, ahead of & behind the rear uprights

Insert the appropriate shims on the pins ahead of the arm (front) / upright (rear), and insert the proper shims behind to remove any slack.

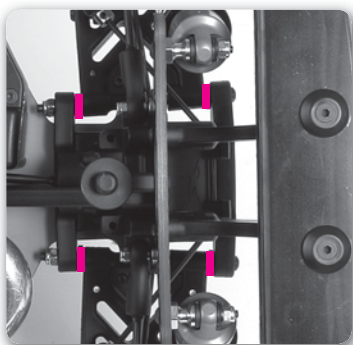

IMPORTANT!

Make equal adjustments on both left and right sides of the car.

1.13 ANTI-ROLL BARS

Anti-roll bars are used to adjust the car's side (lateral) grip. They can also be used in conjunction with a softer spring rate to handle bumpy tracks more efficiently without excessive chassis roll at mid-corner. Anti-roll bars resist chassis roll and by doing so transfer wheel load from the inside wheel to the outside wheel. The stiffer the anti-roll bar, the more load is transferred. However, as the outside wheel is not able to convert the extra wheel load into extra grip, the sum of the grip of both wheels is actually reduced. This changes the balance of the car to the axle at the other end of the car; increasing the stiffness of an anti-roll bar on one particular axle (front or rear) decreases the side grip of that axle and increases the side grip of the axle at the other end of the car.

The overall traction of a car cannot be changed, but it can be balanced by distributing wheel loads. Anti-roll bars are a very useful tool to change the balance of the car. Chassis stiffness plays a very important role in the effectiveness of anti-roll bars, and a stiffer chassis makes the car more responsive to anti-roll bar changes.



The front anti-roll bar affects mainly off-power steering at corner entry. The rear anti-roll bar affects mainly on-power steering and stability in mid-corner and at corner exit.

EFFECTS OF ANTI-ROLL BAR ADJUSTMENT

ANTI-ROLL BAR STIFFNESS	CHARACTERISTICS
FRONT	
Softer (thinner wire)	<ul style="list-style-type: none">• Increases front chassis roll• Increases front traction• Decreases rear traction• Increases off-power steering (may cause oversteer)
Stiffer (thicker wire)	<ul style="list-style-type: none">• Decreases front chassis roll• Decreases front traction• Decreases off-power steering at corner entry (increases understeer)• Quicker steering response
REAR	
Softer (thinner wire)	<ul style="list-style-type: none">• Increases rear chassis roll• Increases rear traction• Decreases front traction• Decreases on-power steering (increases understeer)
Stiffer (thicker wire)	<ul style="list-style-type: none">• Decreases rear chassis roll• Decreases rear traction• Increases front traction• Increases on-power steering (may cause oversteer)• Quicker steering response in high speed chicanes

ADJUSTING ANTI-ROLL BARS

Adjust the stiffness of the front or rear anti-roll bar by using a thinner or thicker wire.

1.14 REAR WING

The angle and position of the rear wing affects stability at various speeds, increases or decreases rear traction, and also affects car attitude when jumping.

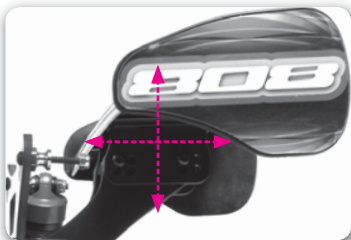

EFFECTS OF REAR WING ADJUSTMENT

WING POSITION/ANGLE	CHARACTERISTICS
Higher	<ul style="list-style-type: none">Increases stability at higher speeds
Lower	<ul style="list-style-type: none">Increases stability at lower speeds
Forward	<ul style="list-style-type: none">Decreases rear traction
Rearward	<ul style="list-style-type: none">Increases rear traction
Flatter angle	<ul style="list-style-type: none">Level jumping or nose-diving
Steeper angle	<ul style="list-style-type: none">Increases traction at higher speedsLess nose-diving

ADJUSTING THE REAR WING

Adjust the position and angle of the rear wing using the different mounting position on the wing supports. You can also add shims between the rear bulkhead and the rear wing posts to move the wing further rearward.

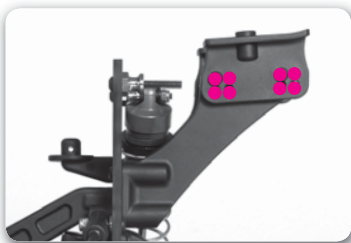

IMPORTANT!

Make equal adjustments on both left and right sides of the car.

2.0 CLUTCH

A properly set up clutch will have a dramatic impact on the performance and drivability of your off-road car. It is important to note that there are many factors that may affect engine and clutch performance, including engine tuning, proper clutch assembly, clutch shimming, spring rate, and shoe orientation can all affect clutch performance.



2.0.1 CLUTCH SPRINGS

Clutch springs affect the engagement point of the clutch.

EFFECTS OF CLUTCH SPRING STIFFNESS

CLUTCH SPRINGS	CHARACTERISTICS
Thinner (softer)	<ul style="list-style-type: none">• Clutch engages earlier at lower RPM• More gradual acceleration• Easier to drive but not as aggressive• Easier to drive on low-grip tracks
Thicker (stiffer)	<ul style="list-style-type: none">• Clutch engages later at higher RPM• More sudden acceleration• Car is more aggressive• Engine will perform better on high-grip tracks

ADJUSTING CLUTCH SPRINGS

Adjust the engagement characteristics of the clutch by using different clutch springs.



2.0.2 CLUTCH SHOE ORIENTATION

The orientation of the clutch shoes affects how aggressively the clutch engages.

EFFECTS OF CLUTCH SHOE ORIENTATION

CLUTCH SHOE ORIENTATION	CHARACTERISTICS
Trailing shoes	<ul style="list-style-type: none">• Clutch engages more smoothly• More ideal for slick track conditions
Leading shoes	<ul style="list-style-type: none">• Clutch engages more aggressively• More ideal on high-traction tracks

ADJUSTING CLUTCH SHOE ORIENTATION

Adjust the engagement characteristics of the clutch by changing the orientation of the clutch shoes on the flywheel pins.

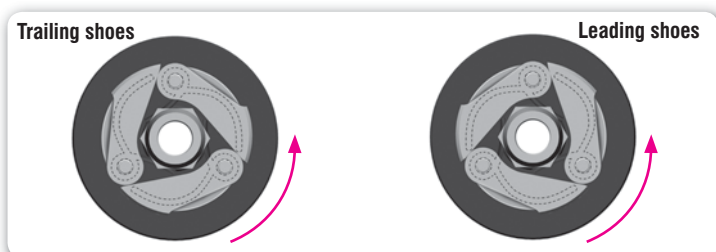

2.1 DIFFERENTIALS

Off-road cars typically feature sealed gear differentials at the front, center, and rear. The characteristics of the differentials may be adjusted by using thinner or thicker differential oils inside their cases. Optional differentials – such as the XRAY Active Diff™ – may also be used to replace the standard front differential.



2.1.1 DIFFERENTIAL OIL

You can adjust the characteristics of the differentials by using thinner or thicker silicone oil within their cases.

- Changing the oil in the front differential affects overall steering response.
- Changing the oil in the center differential affects the front-to-rear drive.
- Changing the oil in the rear differential affects cornering traction and overall steering.

We recommend using only highest-grade XRAY Silicone Oil, which is available in numerous viscosities. XRAY Silicone Oil is specially formulated to be temperature-resistant and low-foaming for use in XRAY differentials. To be able to compare your setup with other XRAY drivers, we advise using only XRAY Silicone Oil.

XRAY PREMIUM SILICONE OIL			
# 359301	1 000 cSt	# 359340	40 000 cSt
# 359302	2 000 cSt	# 359350	50 000 cSt
# 359303	3 000 cSt	# 359360	60 000 cSt
# 359305	5 000 cSt	# 359380	80 000 cSt
# 359307	7 000 cSt	# 359392	100 000 cSt
# 359310	10 000 cSt	# 359394	150 000 cSt
# 359320	20 000 cSt	# 359396	200 000 cSt
# 359330	30 000 cSt	# 359398	300 000 cSt

EFFECTS OF DIFFERENTIAL OIL REPLACEMENT

DIFF	OIL THICKNESS	CHARACTERISTICS
Front	Thinner	<ul style="list-style-type: none"> • Increases steering into corners (off-power) • If oil is too thin the steering may become inconsistent, especially it can lose forward traction (and steering) during acceleration out of corners
	Thicker	<ul style="list-style-type: none"> • Increases stability into corners during braking • Increases steering on-power at corner exit
Center	Thinner	<ul style="list-style-type: none"> • Front wheels unload more during acceleration • Decreases on-power steering (reduces oversteer) • Easier to drive on rough tracks • If a high-power engine is used you could waste too much power and sometime “cook” the oil in the center differential because it “overloads” • More off-power steering
	Thicker	<ul style="list-style-type: none"> • More all-wheel drive effect • Better acceleration • Increases on-power steering (reduces understeer) • Better suited on high-bite, smooth tracks • Car can be more nervous to drive especially if a high power engine is used - you might need to be smooth on the throttle
Rear	Thinner	<ul style="list-style-type: none"> • Increases cornering traction • Increases steering into corner
	Thicker	<ul style="list-style-type: none"> • Decreases rear traction while cornering • Reduces wheelspin

2.1.2 DIFFERENTIAL GEARS

Another tuning option for the differentials is to change the outer crown or spur gears to tailor the car to your driving style or track conditions. Note that overdrive changes are only done in the front.



EFFECTS OF DIFFERENTIAL GEAR REPLACEMENT



GEAR	WHEN TO USE
FRONT	
Larger front gear (more teeth)	<ul style="list-style-type: none"> Using a larger front gear is NOT recommended
Standard	<ul style="list-style-type: none"> Standard gear works well on most tracks and conditions
Smaller front gear (less teeth)	<ul style="list-style-type: none"> Recommended for slippery tracks Gain more overall steering and makes car easier to drive Rear end follows the car around
CENTER	
Larger center gear (more teeth)	<ul style="list-style-type: none"> Increases acceleration Decreases top speed Use on smaller track to get more punch Use with a larger clutchbell to get more overall torque while maintaining the same gear ratio
Standard	<ul style="list-style-type: none"> Standard gear works well on most tracks and conditions
Smaller center gear (less teeth)	<ul style="list-style-type: none"> Decreases acceleration, but smoother Increases top speed
REAR	
Larger rear gear (more teeth)	<ul style="list-style-type: none"> Recommended for slippery tracks Underdrives the rear end with the same effect as a smaller front gear
Standard	<ul style="list-style-type: none"> Standard gear works well on most tracks and conditions
Smaller rear gear (less teeth)	<ul style="list-style-type: none"> Using a smaller rear gear is NOT recommended

2.1.3 OPTIONAL DIFFERENTIALS (XRAY ACTIVE DIFF™)

The XRAY Active Differential™ is a high-performance, adjustable front gear differential for XRAY 1/8 nitro off-road cars & truggies. It vastly improves the car's speed and handling characteristics. The special design of the internal components – using different angled segments – allows the diff gears to engage on-power to increase the forward traction and stability to the buggy, making it faster and easier to drive.



- High-performance adjustable front Active Differential for improved speed & handling
- Designed for XB8-based models
- Fully-adjustable on- and off-power performance using different internal segments and gears
- Improves diff action and increases traction
- Easy and consistent steering

SEGMENT	AVAILABLE	WHEN TO USE
 90°	The standard 90° segment provides a very good balance of performance between on- and off-power. On-power the diff becomes hard after a brief delay. Off-power the diff becomes free after a brief delay.	Recommended for high grip and/or bumpy tracks.
 120°	The optional 120° segment gives more immediate response both on- and off-power. On-power the diff becomes very hard immediately (no delay). Off-power the diff becomes free immediately (no delay).	Recommended for slippery and/or flat tracks.

ACTION	EFFECT
Off-power Action	Off-power the Active Diff works the same way as standard front differential, so adjustment is made by using different viscosities of silicone oil to get the desired off power steering. The softer the oil, the more off-power steering but the car will be more aggressive.
On-power Action	The main advantage of the Active Diff is readily apparent when on-power. The diff becomes harder and more locked when throttle is applied, giving a lot of forward traction and stability to the car.

GEAR	WHEN TO USE
Standard / Larger Gear	Standard / larger gear recommended for tracks with good grip
Optional / Smaller Gear	Optional / smaller gear recommended for slippery tracks. Increases stability but introduces slight amount of on-power understeer

2.2 GEARING

Proper gearing is one of the most essential tuning options required to maximize the performance potential of your car.



2.2.1 PRIMARY DRIVE RATIO

Most modern off-road cars & truggies (including the XRAY XB808) feature a single-speed transmission, so gearing is adjusted by changing the pinion gear (on the clutchbell) and the spur gear (on the central differential)... also known as the “primary drive ratio (PDR).” It is very important to establish the best gear ratio for each track environment, engine/chassis setup and driving style.

- **Smaller pinion / larger spur** = high gearing (long/tall) = faster acceleration but lower top speed
- **Larger pinion / smaller spur** = low gearing (short) = slower acceleration but higher top speed

2.2.2 GEAR MESH ADJUSTMENT

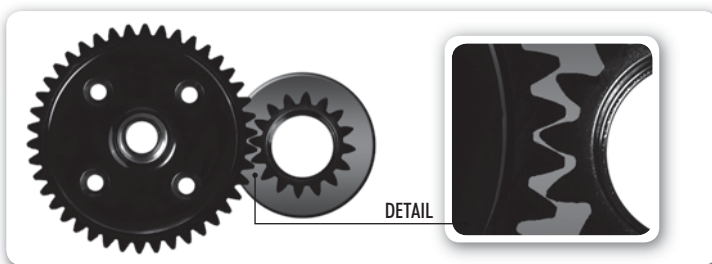

Proper gear mesh between the center diff spur gear and the clutchbell pinion gear is vitally important to obtain optimal drivetrain operation, smoothness, and efficiency. Improper gear mesh can result in a binding drivetrain, overstressed clutch/diff components, and chipped or broken gear teeth.

2.3 WHEELS, TIRES, AND INSERTS

Wheels, tires and inserts — and how they are set up — have a tremendous impact on the overall performance and drivability of the car.

Before you start making changes on the chassis setup, take a moment to observe a few of the fastest cars at the track and what type of tires and inserts they are running. Changing to the best tire combination for the particular track may have a huge impact on handling, performance and significantly reduce your lap times.

Factors like quality, safety, appearance, comfort, and ease-of-use are fundamental design concerns which are addressed during the development and production of any piece of equipment that HUDY makes.

HUDY uses the most modern high-tech engineering technologies available; designing, processing, analyzing, and testing are accomplished with the use of high-end CAD PRO ENGINEER - 3D software system. All advertising and promotion strategies, as well as the whole corporate identity, are executed by a professional team of marketing managers, designers, and developers.

Before beginning production, each prototype is accurately analyzed, and tested in extreme overload conditions. The whole test process is focused on the item's features, its reliability characteristics, and the life span of each of its parts and components, which HUDY strives to maximize.

HUDY's manufacturing facility is the most modern in the RC industry. Hudy employs over 90 professionals, and the manufacturing facility is large over 2000m² and HUDY uses only the most modern, computer controlled, state-of-the-art CNC machines available, to ensure the highest quality products. The production facility consists of six CNC milling machines, four CNC cutting machines, CNC moulding machine, computer controlled injection machine, cutting automats, mills, 10 high-precise grinding machines and plenty of other high-tech equipment.

HUDY is one of the very few authentic manufacturers, and all HUDY products are fully manufactured and assembled in-house to guaranty the highest quality.





#106220 HUDY Bearing Grease

- extended-life multipurpose lubricant for ball bearings
- direct replacement for the grease delivered in ball-bearings
- combines an optimized additive package with proven synthetic-base oils and a robust lithium complex thickener system
- provides outstanding protection against wear, rust, high temperature degradation and demanding startup and heavy loading conditions.



#106221 HUDY Bearing Grease – Extra

- advanced lubricant incorporating both extreme pressure additives and finely dispersed graphite for load carrying
- advanced replacement for the standard bearing grease
- formulated to have excellent adhesion and resistance to “fling-off” under extreme conditions
- provides outstanding protection against wear, rust, high temperature degradation and demanding startup and heavy loading conditions



#106222 HUDY Bearing Grease - Premium

- supreme-performance lubricant for extreme overload conditions in highly-loaded bearings
- combines the unique features of synthetic-base fluids with those of a high-quality lithium complex thickener
- wax-free nature of synthetic fluids and low coefficient of friction provide very low running torque.
- reduces operating temperatures in the load zone of spherical roller- and ball-bearings
- lithium complex thickener contributes excellent adhesion, structural stability and resistance to water
- high level of chemical stability, formulated with special additive combinations to provide excellent protection against wear, rust and corrosion at high and low temperatures



#106210 HUDY Graphite Grease

- high-performance, advanced-technology semi-fluid
- special formulation provides outstanding load-carrying and anti-wear properties
- superior protection against wear, resulting in reduced gear replacement costs and increased part life
- efficient operation, good low temperature start-up and reduced energy consumption
- very good protection against rust and corrosion
- very good adhesion reduces fling-off and consumption



#106211 HUDY Diff Grease

- high-performance, model racing car general-purpose silicone based grease, formulated to provide extra protection against wear, corrosion, and water
- excellent resistance to thermal, oxidative and structural degradation
- extended grease life and improved bearing protection
- excellent resistance to water wash-out and spray-off
- assures proper lubrication and protection in wet environments
- excellent rust and corrosion resistance
- very good anti-wear properties



#106230 HUDY Bearing Oil

- high-quality HUDY Bearing Oil is used to lubricate bearings for ultra-smooth operation and long lifespan
- very good for use on dusty tracks and carpet tracks because it helps combat the effects of dust and carpet hair contamination
- super thin to help promote quick penetration and fast & easy coverage
- recommended for use immediately after bearing cleaning (e.g. with spray cleaner)



XRAY Premium Silicone Oils

- high-quality, lab-certified line of oils that will make “dialing in” quicker and easier
- created exclusively for XRAY by a specialized European silicone oil premium manufacturer
- each batch of premium oil is laboratory tested and calibrated to ensure the highest possible consistency and quality from batch to batch
- based on industry-proven CST rating
- smart bottle design for quick identification and easy shock filling
- entire range of oils from 100–300,000 cSt for shock absorbers and gear differentials

info@hudy.net

www.hudy.net

HUDY, PRED POLOM 762, 911 01 TRENCIN, SLOVAKIA, EUROPE

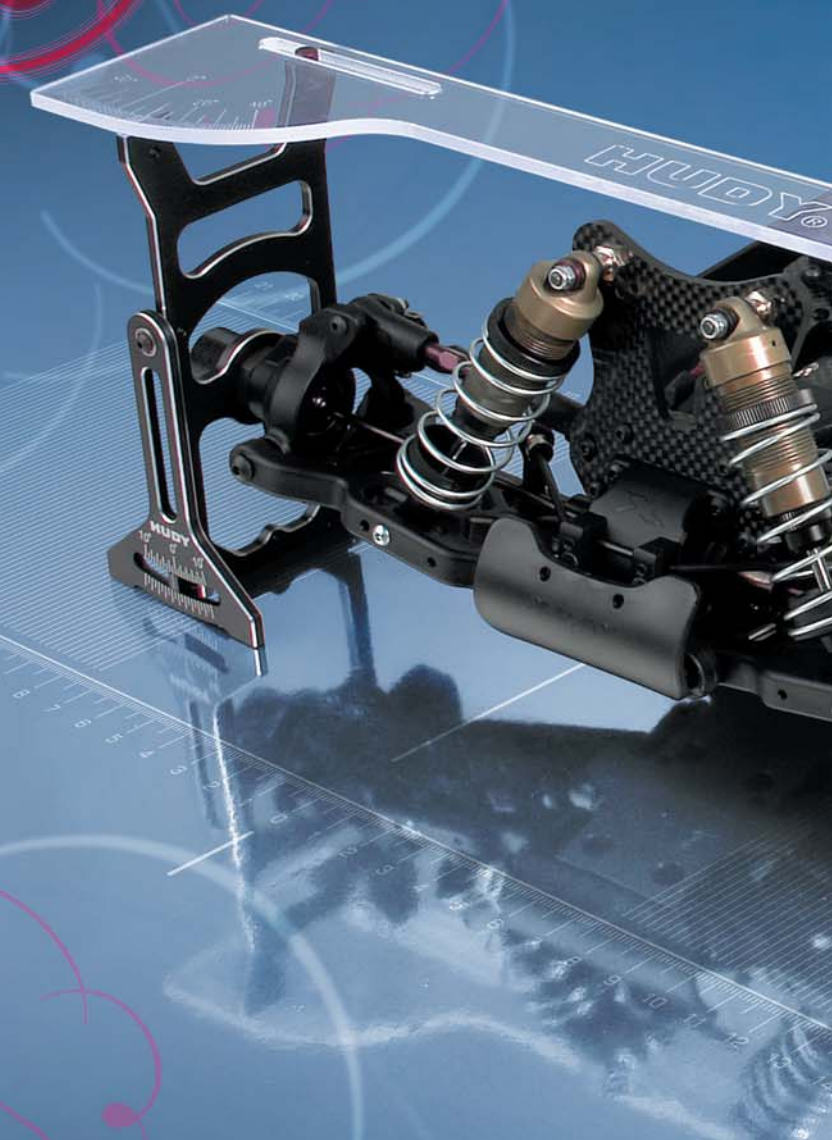

8 581702 090992